



## **SMT inductors**

SIMID series, SIMID 0603-C

**Series/Type:**            **B82496C**  
**Date:**                    March 2008

**SIMID 0603-C**

**SMD**

**Size 0603 (EIA) and/or 1608 (IEC)**  
**Rated inductance 1 nH to 220 nH**  
**Rated current 110 mA to 1800 mA**



**Construction**

- Copper-plated ceramic core
- Laser-cut winding, epoxy-coated

**Features**

- Temperature range up to 150 °C
- High resonance frequency
- Close inductance tolerance
- Free of polarization effect
- High mechanical stability
- Qualified to AEC-Q200
- Suitable for lead-free reflow soldering as referenced in JEDEC J-STD 020C
- RoHS-compatible

**Applications**

Resonant circuits, impedance matching for

- Multimedia
- Car access systems
- Wireless communication systems
- TPMS (Tire Pressure Monitoring System)
- GPS (Global Positioning System)
- Digital cameras

**Terminals**

- Base material Al<sub>2</sub>O<sub>3</sub> ceramic with Cu layer
- Layer composition Ni, Sn (lead-free)
- Electro-plated

**Marking**

- No marking on component
- Minimum data on reel:  
Manufacturer, ordering code, L value,  
quantity, date of packing

**Delivery mode and packing unit**

- 8-mm cardboard tape, wound on 180-mm Ø reel
- Bulk case on request
- Packing unit: 4000 pcs./reel

**SIMID 0603-C**

**SMD**

**Dimensional drawing and layout recommendation**

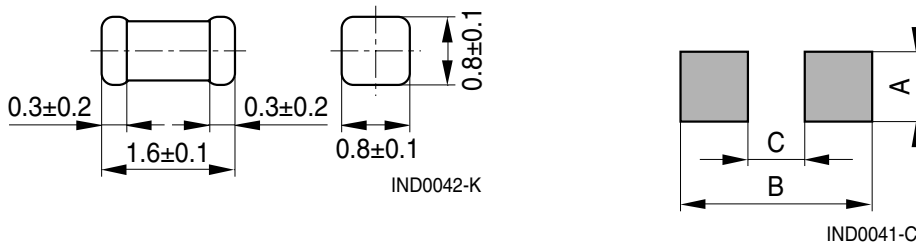

A	B	C
0.8 ± 0.1	2.3 ± 0.3	0.9 ± 0.1

Dimensions in mm

**Taping and packing**

Cardboard tape

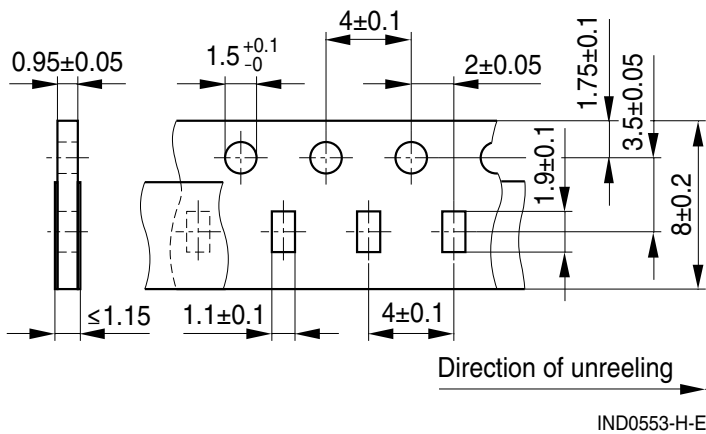

Dimensions in mm

Reel

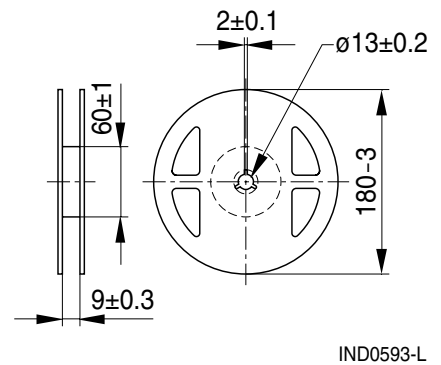

**SMD**
**Technical data and measuring conditions**

Rated inductance $L_R$	Measured with impedance analyzer Agilent 4291A and test fixture Agilent 16196A at frequency $f_L$ , 0.1 V, 20 °C
Q factor $Q_{\min}$ , $Q_{\text{typ}}$	Measured with impedance analyzer Agilent 4291A and test fixture Agilent 16196A, $Q_{\min}$ measured at frequency $f_Q$ , 20 °C
Rated temperature $T_R$	125 °C
Rated current $I_R$	Maximum permissible DC with a temperature increase of $\leq 15$ K at rated temperature
Self-resonance frequency $f_{\text{res},\min}$	Measured with network analyzer Agilent 8720D, 20 °C
DC resistance $R_{\text{max}}$	Measured at 20 °C
Solderability (lead-free)	Sn95.5Ag3.8Cu0.7: (245 $\pm$ 5) °C, (5 $\pm$ 0.3) s Wetting of soldering area $\geq 95\%$ (based on IEC 60068-2-58)
Resistance to soldering heat	260 °C, 40 s (as referenced in JEDEC J-STD 020C)
Climatic category	55/150/56 (to IEC 60068-1)
Storage conditions	Mounted: -55 °C ... +150 °C Packaged: -25 °C ... +40 °C, $\leq 75\%$ RH
Weight	Approx. 4 mg

**Characteristics and ordering codes**

$L_R$ nH	Tolerance	$Q_{\min}$	$Q_{\text{typ}}$ (at 800 MHz)	$f_L; f_Q$ MHz	$I_R$ mA	$R_{\max}$ $\Omega$	$f_{\text{res,min}}$ GHz	Ordering code <sup>1)2)</sup> (reel packing)
1.0	$\pm 0.3 \text{ nH} \triangleq \text{A}$	7	60	100	1800	0.02	16	B82496C3109+000
1.2	$\pm 0.2 \text{ nH} \triangleq \text{Z}$	8	60	100	1800	0.025	15	B82496C3129+000
1.5		8	50	100	1500	0.03	13	B82496C3159+000
1.8		12	50	100	1500	0.033	12	B82496C3189+000
2.2		14	50	100	1500	0.035	10	B82496C3229+000
2.7		14	40	100	1400	0.04	10	B82496C3279+000
3.3		14	40	100	1200	0.06	9	B82496C3339+000
3.9		$\pm 5\% \triangleq \text{J}$ $\pm 0.2 \text{ nH} \triangleq \text{Z}$	14	40	100	1100	0.065	8
4.7	14		40	100	800	0.10	7	B82496C3479+000
5.6	14		40	100	700	0.15	6	B82496C3569+000
6.8	14		40	100	700	0.15	6	B82496C3689+000
8.2	14		40	100	650	0.18	6	B82496C3829+000
10	$\pm 5\% \triangleq \text{J}$ $\pm 2\% \triangleq \text{G}$		14	40	100	600	0.20	5
12		14	40	100	450	0.35	5	B82496C3120+000
15		14	40	100	420	0.40	4.5	B82496C3150+000
18		14	40	100	400	0.45	4.0	B82496C3180+000
22		14	40	100	380	0.50	4.0	B82496C3220+000
27		14	35	100	360	0.55	3.0	B82496C3270+000
33		14	35	100	350	0.60	3.0	B82496C3330+000
39		14	35	100	300	0.80	2.5	B82496C3390+000
47		14	35	100	270	0.95	2.5	B82496C3470+000
56		14	35	100	250	1.2	2.5	B82496C3560+000
68		14	35	100	230	1.3	2.0	B82496C3680+000
82		14	35	100	220	1.5	2.0	B82496C3820+000
100		14	30	100	200	1.8	1.8	B82496C3101+000
120		5	30	25.2	160	3.0	1.8	B82496C3121+000
150	5	30	25.2	130	5.0	1.6	B82496C3151+000	
180	4	25	25.2	120	6.0	1.4	B82496C3181+000	
220	4	25	25.2	110	7.0	1.3	B82496C3221+000	

Special versions on request.

Higher currents possible at temperatures  $< T_R$  on request.

Sample kit available (see also chapter "Sample kits". Ordering code: B82496X001

1) Replace the + by the code letter for the required inductance tolerance.

2) For bulk case the last digit has to be a »1«. Example: B82496C3109A001

**SMD**

**Impedance  $|Z|$  versus frequency  $f$**   
 measured with impedance analyzer  
 Agilent 4291A/16196A, typical values at 20 °C

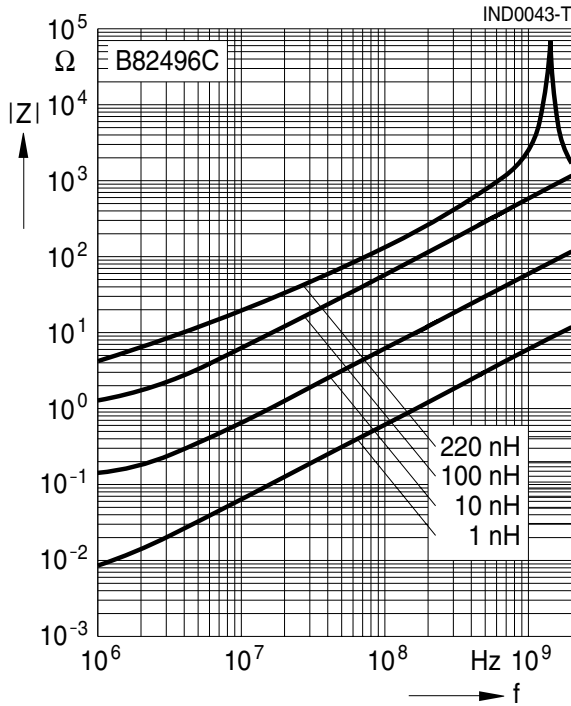

**Inductance  $L$  versus DC load current  $I_{DC}$**   
 measured with LCR meter Agilent 4275A,  
 typical values at 20 °C

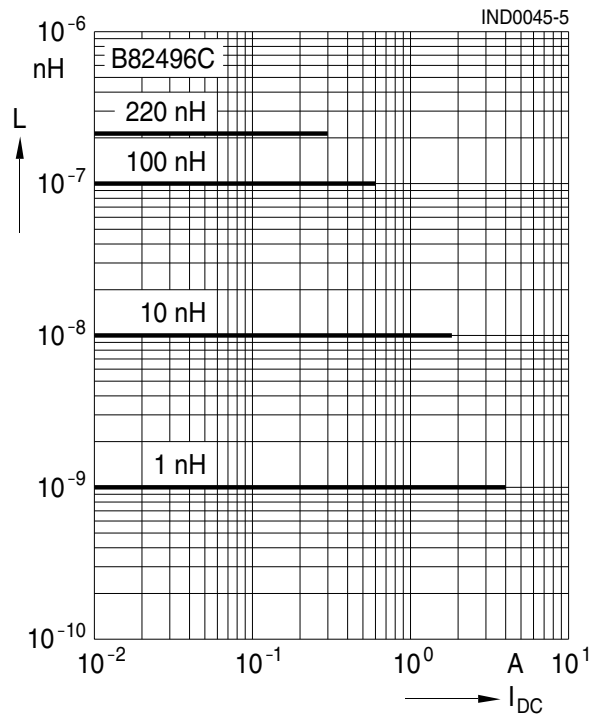

**Q factor versus frequency  $f$**   
 measured with impedance analyzer  
 Agilent 4291A/16196A, typical values at 20 °C

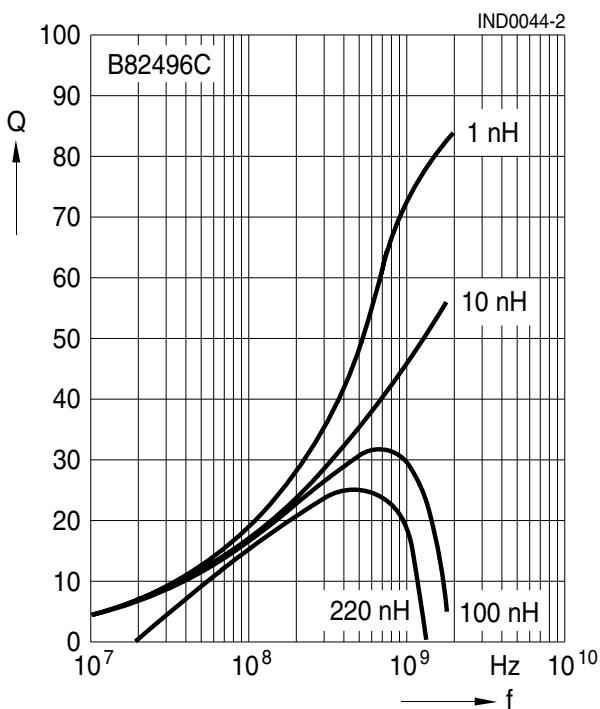

**Current derating  $I_{op}/I_R$**   
**versus ambient temperature  $T_A$**   
 (rated temperature  $T_R = 125$  °C)

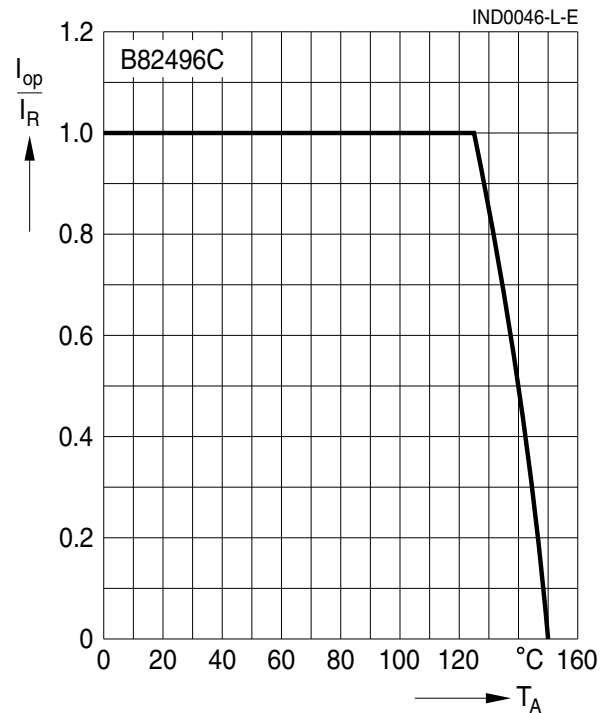

## Cautions and warnings

- Please note the recommendations in our Inductors data book (latest edition) and in the data sheets.
  - Particular attention should be paid to the derating curves given there.
  - The soldering conditions should also be observed. Temperatures quoted in relation to wave soldering refer to the pin, not the housing.
- If the components are to be washed varnished it is necessary to check whether the washing varnish agent that is used has a negative effect on the wire insulation, any plastics that are used, or on glued joints. In particular, it is possible for washing varnish agent residues to have a negative effect in the long-term on wire insulation.
- The following points must be observed if the components are potted in customer applications:
  - Many potting materials shrink as they harden. They therefore exert a pressure on the plastic housing or core. This pressure can have a deleterious effect on electrical properties, and in extreme cases can damage the core or plastic housing mechanically.
  - It is necessary to check whether the potting material used attacks or destroys the wire insulation, plastics or glue.
  - The effect of the potting material can change the high-frequency behaviour of the components.
- Ferrites are sensitive to direct impact. This can cause the core material to flake, or lead to breakage of the core.
- Even for customer-specific products, conclusive validation of the component in the circuit can only be carried out by the customer.

## Important notes

The following applies to all products named in this publication:

1. Some parts of this publication contain **statements about the suitability of our products for certain areas of application**. These statements are based on our knowledge of typical requirements that are often placed on our products in the areas of application concerned. We nevertheless expressly point out **that such statements cannot be regarded as binding statements about the suitability of our products for a particular customer application**.

As a rule, EPCOS is either unfamiliar with individual customer applications or less familiar with them than the customers themselves. For these reasons, it is always ultimately incumbent on the customer to check and decide whether an EPCOS product with the properties described in the product specification is suitable for use in a particular customer application.

2. We also point out that **in individual cases, a malfunction of passive electronic components or failure before the end of their usual service life cannot be completely ruled out in the current state of the art, even if they are operated as specified**. In customer applications requiring a very high level of operational safety and especially in customer applications in which the malfunction or failure of a passive electronic component could endanger human life or health (e.g. in accident prevention or life-saving systems), it must therefore be ensured by means of suitable design of the customer application or other action taken by the customer (e.g. installation of protective circuitry or redundancy) that no injury or damage is sustained by third parties in the event of malfunction or failure of a passive electronic component.
3. **The warnings, cautions and product-specific notes must be observed.**
4. In order to satisfy certain technical requirements, **some of the products described in this publication may contain substances subject to restrictions in certain jurisdictions (e.g. because they are classed as hazardous)**. Useful information on this will be found in our Material Data Sheets on the Internet ([www.epcos.com/material](http://www.epcos.com/material)). Should you have any more detailed questions, please contact our sales offices.
5. We constantly strive to improve our products. Consequently, **the products described in this publication may change from time to time**. The same is true of the corresponding product specifications. Please check therefore to what extent product descriptions and specifications contained in this publication are still applicable before or when you place an order.

We also **reserve the right to discontinue production and delivery of products**. Consequently, we cannot guarantee that all products named in this publication will always be available.

The aforementioned does not apply in the case of individual agreements deviating from the foregoing for customer-specific products.

6. Unless otherwise agreed in individual contracts, **all orders are subject to the current version of the “General Terms of Delivery for Products and Services in the Electrical Industry” published by the German Electrical and Electronics Industry Association (ZVEI)**.
7. The trade names EPCOS, BAOKE, Alu-X, CeraDiode, CSSP, CTVS, DSSP, MiniBlue, MKK, MLSC, MotorCap, PCC, PhaseCap, PhaseMod, SIFERRIT, SIFI, SIKOREL, SilverCap, SIMDAD, SIMID, SineFormer, SIOV, SIP5D, SIP5K, ThermoFuse, WindCap are **trademarks registered or pending** in Europe and in other countries. Further information will be found on the Internet at [www.epcos.com/trademarks](http://www.epcos.com/trademarks).